

# Operating Manual

## Refrigerated and Heating Circulators

FS18-HD

F25-HD

F26-HD

F32-HD

F33-HD

F34-HD

F33-SD

- with proportional cooling capacity control

FP40-HD / SD

FP45-HD / SD

FP50-HD / SD

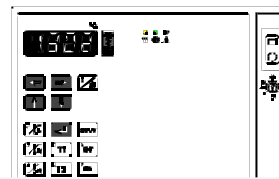

FOR SALES AND SERVICE PLEASE CALL:

PTB SALES T :: 866.332.0500  
F :: 626.334.2151  
www.ptbsales.com

DATE SERVICED: \_\_\_\_\_

**VIEW OUR INVENTORY**

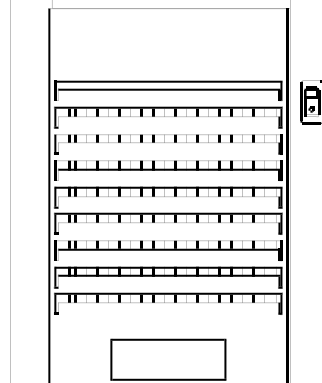

# Julabo®

JULABO USA, Inc.  
754 Roble Road, Suite 180  
Allentown, PA 18103  
☎ (610) 231-0250 📠 (610) 231-0260  
EMAIL us: info @ julabo.com  
ONLINE Catalog: www.julabo.com

Changes without prior notification reserved  
1.953.2420BU6 02/03

19532420.DOC

---

## Congratulations!

You have made an excellent choice.

JULABO thanks you for the trust you have placed in us.

This operating manual has been designed to help you gain an understanding of the principles of operating and possibilities of our circulators. For optimum utilization of all functions, we recommend that you thoroughly study this manual prior to beginning operation.

## Safety Warnings

Take care your unit is operated only by qualified persons.

Make sure you read and understand all instructions and safety precautions listed in this manual before installing or operating your unit. If you have any questions concerning the operation of your unit or the information in this manual, contact JULABO.

Performance of installation, operation, or maintenance procedures other than those described in this manual may result in a hazardous situation and may void the manufacturer's warranty.

Transport the unit with care. Sudden jolts or drops may cause damages in the interior of the unit.

Observe all warning labels.

Never remove warning labels.

Never operate damaged or leaking equipment.

Never operate the unit without bath fluid in the bath.

Always turn off the unit and disconnect the mains cable from the power source before performing any service or maintenance procedures, or before moving the unit.

Always empty the bath before moving the unit.

Never operate equipment with damaged mains power cables.

Refer service and repairs to a qualified technician.









In addition to the safety warnings listed above, warnings are posted throughout the manual. These warnings are designated by an exclamation mark inside an equilateral triangle. Read and follow these important instructions. Failure to observe these instructions can result in permanent damage to the unit, significant property damage, personal injury or death.









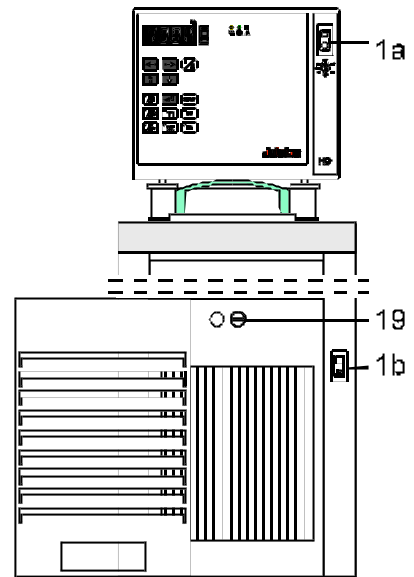

## TABLE OF CONTENTS

1.	OPERATING CONTROLS AND FUNCTIONAL ELEMENTS.....	4
2.	QUALITY MANAGEMENT SYSTEM.....	6
3.	UNPACKING AND CHECKING .....	6
4.	DESCRIPTION .....	6
5.	PREPARATIONS .....	7
5.1.	Installation.....	7
5.2.	Bath liquids and tubing.....	7
5.3.	Filling / draining.....	9
5.4.	Temperature application to external systems.....	10
6.	OPERATING PROCEDURES.....	12
6.1.	Power connection.....	12
6.2.	Switching on - Start/Stop .....	12
6.3.	Setting the temperatures .....	14
6.4.	Warning functions .....	15
6.5.	Setting the safety temperature (with shutdown function) .....	16
6.6.	Internal / external control.....	17
6.7.	PID control parameters.....	18
7.	MENU FUNCTIONS .....	19
7.1.	ATC - Absolute Temperature Calibration.....	20
7.2.	Id - Identification.....	21
7.3.	h - Heater capacity .....	22
7.4.	r - Remote.....	22
7.5.	br - Baud rate .....	23
7.6.	P - Parity.....	23
7.7.	H - Handshake .....	23
7.8.	Sb - Stand-By.....	23
7.9.	Pr - Programmer type .....	23
7.10.	Ad - Address .....	24
7.11.	Signal level RS232/RS485 .....	24
8.	TROUBLESHOOTING GUIDE / ERROR MESSAGES .....	25
9.	SAFETY RECOMMENDATIONS .....	27
10.	ELECTRICAL CONNECTIONS.....	28
11.	REMOTE CONTROL .....	31
11.1.	Setup for remote control.....	31
11.2.	Communication with a PC or a superordinated data system .....	31
11.3.	List of commands.....	33
11.4.	Status messages / error messages.....	36
12.	MAINTAINING THE COOLING PERFORMANCE.....	38
13.	CLEANING THE UNIT, MAINTENANCE .....	39
14.	TECHNICAL SPECIFICATIONS .....	40
15.	WARRANTY CONDITIONS .....	44

# 1. Operating controls and functional elements

- 1a/1b Mains power switch, illuminated  
Circulator/Cooling machine
- 2  Start / stop key
- 3  Working temperature T1
- 4  Working temperature T2
- 5  High temperature warning limit
- 6  Low temperature warning limit
- 7  Safety temperature
- 8  Adjustable excess temperature protection  
(safety temperature)



- 9  Display of internal/external actual value
- 10  Control type: internal/external control
- 11  Control parameters Xp, Tn, Tv
- 12  MULTI-DISPLAY (LED) temperature indication
- 
  - Ext - external actual value (ext Pt100)
  - Xp, Tn, Tv - control parameters
  - Eprog - analog programmer signal
  - RS232 - remote control with a PC
-  Indicator light - Alarm
-  Indicator light - Cooling (not operational)
-  Indicator light - Heating
- 13  Cursors left/right
- 14  Edit keys (increase/decrease setting)
- 15  Enter key (store/quitting the audible signal)
- 19 Drain tap with drain port

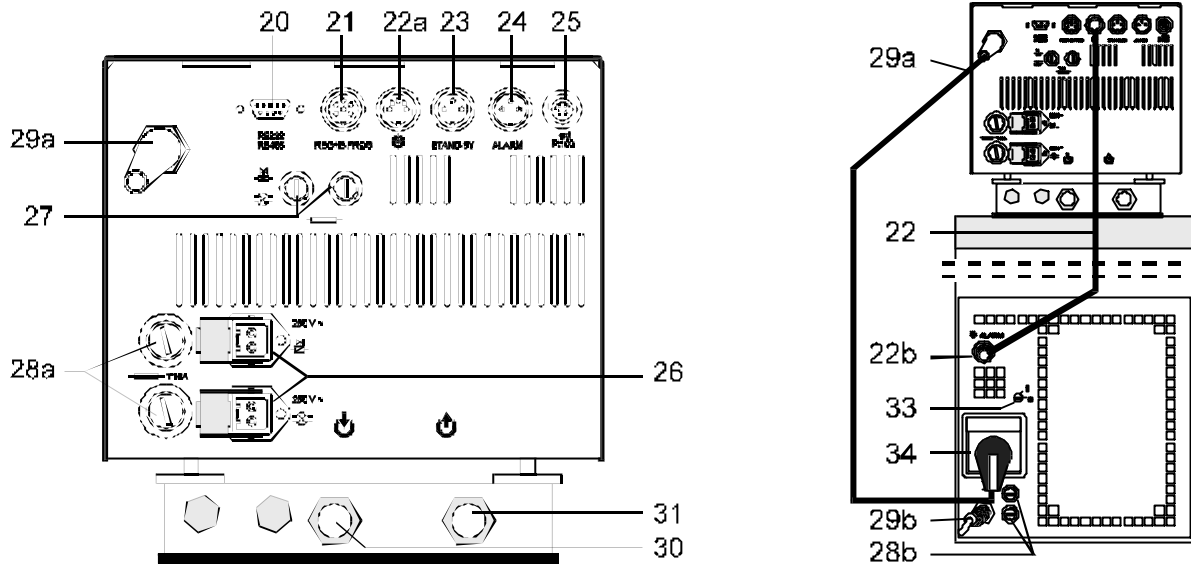

Rear

20		RS232 RS485	Interface RS232/RS485
21		REG+E-PROG	Programmer input and temperature recorder output
22a/22b			Connector: control cable of JULABO refrigerated circulator
23		STAND-BY	Stand-by input (for external emergency switch-off)
24		ALARM	Alarm output (for external alarm signal)
25			Connector for external measurement and control sensor
26			Connectors for solenoid valve and/or supplementary pump 230 V / 115 V
27			Fuses M 1.25 A / M 2.5 A (for connectors 26)
28a/28b			Mains fuses: Circulator Cooling machine
29a/29b			Mains power cable with plug: Circulator/Cooling machine
30 + 31			Pump connectors  suction pump  pressure pump
33			Selector dial for cooling machine (only on F25, F34) Position „1“ for operation with circulator
34			Built-in mains outlet for connection of circulator
			Only for water cooled models: Cooling water OUTLET and INLET

## 2. Quality Management System



The JULABO Quality Management System:

Development, production and distribution of temperature application instruments for research and industries conform to the requirements according to DIN EN ISO 9001:1994-08.

Certificate Registration No. QA 051004008.

## 3. Unpacking and checking

Unpack the circulator and accessories and check for damages incurred during transit. These should be reported to the responsible carrier, railway, or postal authority, and a request for a damage report should be made. These instructions must be followed fully for us to guarantee our full support of your claim for protecting against loss from concealed damage. The form required for filing such a claim will be provided by the carrier.

## 4. Description

The JULABO refrigerated circulators employ a circulator head and a cooling machine with bath tank, and have been designed for heating and cooling of liquids in a bath tank.

Besides the cooling aggregate, the main functional elements are the heater, circulation pump, and control electronics. An electronic proportional temperature control (PID characteristic) adapts the heat supplied to the thermal requirements of the bath.

Setting is rapid and simple using the keypad with its easy to learn symbols. Keypad is splash-proof, easily cleaned and ergonomically designed.

The microprocessor technology allows four temperature values to be stored and indicated on the MULTI-DISPLAY (LED): working temperatures T1 and T2, high and low temperature warning limits.

The safety value for excess temperature protection, a safety installation independent from the control circuit, is adjustable on the front with simultaneous indication on the MULTI-DISPLAY (LED).

The RS232/RS485 port permits modern process engineering without additional interface, directly on-line, from the circulator to your application equipment.

Besides the digital interface, additionally analog connectors are provided, such as for Pt100 external sensor, analog programmer input, temperature recorder output and others.

The circulator conforms to the safety requirements specified by DIN 12 876 (safety class III), as well as DIN 58 966, and the guideline for first voltage range EN 61010.

## 5. Preparations

### 5.1. Installation

- Place the unit in an upright position.
- Keep at least 20 cm of open space on the front and rear venting grids.
- Do not set up the unit in the immediate vicinity of heat sources and do not expose to sun light.
- Before operating the unit after transport, wait about one hour after setting it up. This will allow any oil that has accumulated laterally during transport to flow back down thus ensuring maximum cooling performance of the compressor.
- Only for water cooled models:  
Ensure circulation of cooling water by connecting the tubing to cooling water inlet and outlet on the rear of the refrigerated circulator.  
Cooling water connectors: ½"  
Cooling water see page 43

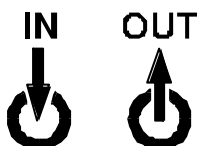

### 5.2. Bath liquids and tubing



**Carefully read the safety data sheet of the bath liquid used, particularly with regard to the fire point!**

**If Ethanol is used, only supervised operation is possible.**

- **Recommended bath liquids:**

Bath liquids	Temperature range	Flash point	fire point
Thermal M	+50 °C ... 170 °C	>275 °C	>320 °C
Thermal H	+50 °C ... 250 °C	>280 °C	>350 °C
Thermal HY	-60 °C ... 50 °C	>62 °C	>110 °C
Ethanol (C <sub>2</sub> H <sub>5</sub> OH)	-100°C bis 0 °C	12 °C	
deionized water	5 °C bis 80 °C		

**ATTENTION:** The maximum permissible viscosity is 30 mm<sup>2</sup> x s<sup>-1</sup>.



**Please contact JULABO before using other than recommended bath liquids.**

**JULABO takes no responsibility for damages caused by the selection of an unsuitable bath liquid.**

**Unsuitable bath liquids are liquids which e.g.**

- **are very highly viscous**  
(much higher than  $30 \text{ mm}^2 \times \text{S}^{-1}$  at the respective working temperature)
- **have corrosive characteristics or**
- **tend to cracking.**

Order No.	Bath liquid	
8 940 100	Thermal M	10 liters container
8 940 101	Thermal M	5 liters container
8 940 102	Thermal H	10 liters container
8 940 103	Thermal H	5 liters container
8 940 104	Thermal HY	10 liters container
8 940 105	Thermal HY	5 liters container

• **Recommended tubing:**

	Temperature range
CR tubing	-20 °C to +120 °C
Viton tubing	-50 °C to +200 °C
Metal tubing	-100 °C to +350 °C

### 5.3. Filling / draining

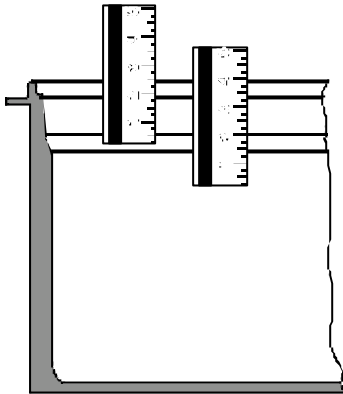

#### Filling

Take care that no liquid enters the interior of the circulator.

- Recommended maximum filling level with water as bath liquid: 25 mm below the tank rim
- Recommended maximum filling level with bath oils: 40 mm below the tank rim

After filling, immerse the samples in the bath or place the lid on the bath, in case the opening is not to be used.

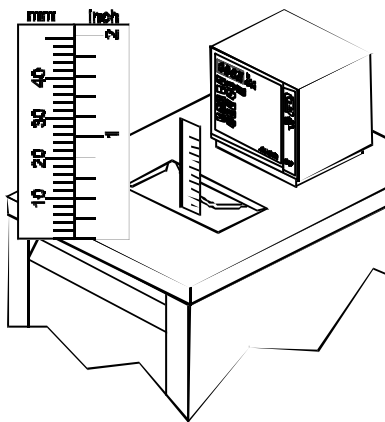

#### **FS18**

- Recommended maximum filling level is 5 mm.

#### Note:

When switching the circulator on, the bath liquid may lie below the required minimum level due to liquid pumped into the external system.



**ATTENTION: The volume of bath oils will increase due to thermal expansion when the bath temperature rises. Exercise CAUTION when emptying hot bath liquids!**

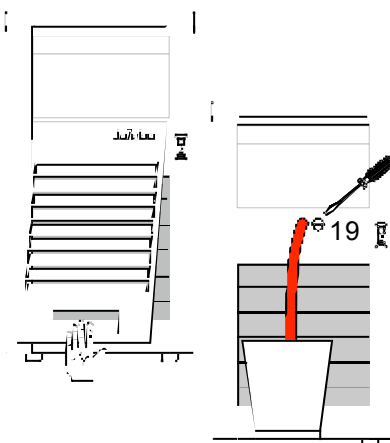

#### Draining

- Turn off the circulator and cooling machine.
- Hold the venting grid, pull out and remove.
- Slide a short piece of tube onto the drain port and hold it into a pail.
- Unscrew the drain tap (19) and empty the unit completely.
- Tighten the drain tap.

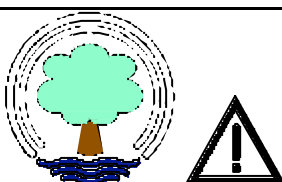



**Store and dispose the used bath liquid according to the laws for environmental protection.**

## 5.4. Temperature application to external systems

### Temperature application to external, closed systems

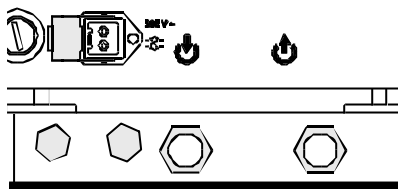
The circulator is used for temperature application to external, closed systems (loop circuit) with simultaneous temperature application in the circulator bath.



- Unscrew the M 16 x 1 collar nuts on the pump connectors (pressure pump , suction pump ) with a 19 mm (3/4") wrench and remove the sealing disks. Using the collar nuts, screw on the tubing connection fittings (for tubing 8 mm or 12 mm in diameter) delivered with the unit and tighten firmly.
- Push on the tubings, and secure with tube clamps.
- Attach the tubings to the connectors of the external closed system, e.g., an instrument with a pressure-resistant temperature jacket or a temperature coil, and fasten with tube clamps to prevent slipping.

### Temperature application to external, open systems

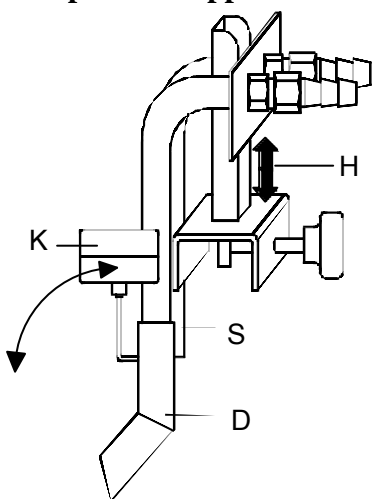

These circulators are equipped with both a pressure and suction pump for external temperature application in open systems.

Differing flow rates of the pressure and suction pumps should be compensated. To maintain a constant liquid level, the JULABO "D+S" Level Adapter is recommended for the external bath tank. The flow rate of the pressure pump will be then regulated by a built-in float device. The liquid level may be changed by a height adjustment on the "D+S" Level Adapter.

Order No. 8 970 410 "D+S" Level Adapter

- S = Suction pump connection  
 D = Pressure pump connection  
 K = Float  
 H = Height adjustment



When working at temperatures below 0 °C and using the "D+S" Level Adapter do not use oil as the bath liquid. Condensing air will result in the formation of ice and thus affects the function of the float.

### Return flow safety device

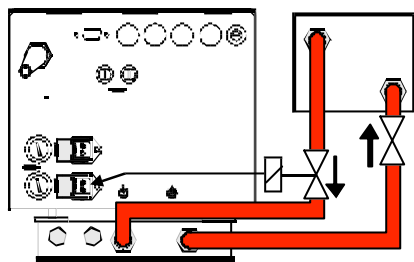

If the liquid levels in the circulator bath and the external system are at different heights, overflowing must be prevented after the power has been turned off.



#### Flood hazard!

For this reason, solenoid valves for loop circuit or shut-off valves can be integrated in the loop circuit.

Connect the valve (230 V / 115 V) to the connector (26).

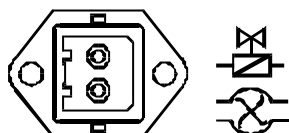

Order No.	Description
8 980 701	Solenoid valve for loop circuit up to +100 °C
8 970 456	Shut-off valve (suitable up to +90 °C)
8 970 457	Shut-off valve (suitable up to +250 °C)



**Fasten tubing to prevent slipping.**

### Supplementary pump

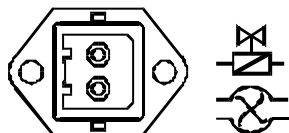

Both connectors (26) may be used for operating supplementary pumps.



Control (switching on/off) is effected by pressing the start/stop key or via the digital interface with the start/stop command.

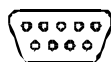

**Check to make sure that the line voltage matches the supply voltage specified on the identification plate (230 V or 115 V).**

## 6. Operating procedures

### 6.1. Power connection



**Connect the unit only to grounded mains power socket!  
Do not use 2-pole adapters!  
We disclaim all liability for damage caused by incorrect line voltages or if the unit has not been connected to ground.**

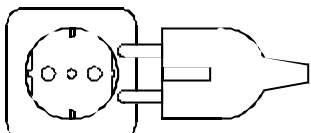

Check to make sure that the line voltage matches the supply voltage specified on the identification plate.  
Deviations of  $\pm 10\%$  are permissible

- Connect the circulator with mains power cable (29a) to the mains outlet (34).
- Connect the control cable (22) between the connectors \* (22a, 22b).
- Connect the refrigerated circulator with mains power cable (29b) to the mains socket.

### 6.2. Switching on - Start/Stop

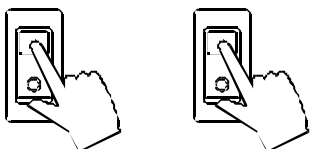

#### Switching on:

Circulator and cooling machine may be turned on and off with separate mains switches. The integrated control light will illuminate to indicate that power has been applied.



The unit performs a self-test. All segments of the 4-digit MULTI-DISPLAY (LED) and all indicator lights will illuminate.

Then the software version (example: n 1.01) appears. The display "OFF" or "r OFF" indicates the unit is ready to operate (stand-by mode).

The circulator enters the operating mode activated before switching the circulator off:

**keypad control mode** (manual operation) or  
**remote control mode** (operation via personal computer).

**Start:**



- Press the start/stop key.
  - The MULTI-DISPLAY (LED) indicates the actual bath temperature. (example: 21.0 °C)
  - An illuminated indicator light in the "T1" or "T2" key indicates the activated working temperature.

**Stop:**



- Press the start/stop key.
  - The MULTI-DISPLAY (LED) indicates the message "OFF".

 The unit also enters the safe operating state "OFF" or "r OFF" after a mains power interruptance. In case of manual operation, the start/stop key has to be pressed to restart operation. The temperature values which were entered via the keypad of the circulator remain in memory.

If the circulator is operated in remote control mode, the order to start and all values which have to be adjusted, must be resent via interface by the personal computer.

**NOTE:**



The circulator has been configured and supplied by JULABO according to N.A.M.U.R. recommendations. This means for the start mode, that the unit must enter a safe operating state after a power failure (non-automatic start mode). This safe operating state is indicated by „OFF“ or „rOFF“, resp. on the MULTI-DISPLAY (LED). A complete shutdown of the main functional elements such as heater and circulation pump is effected simultaneously.

Should such a safety standard not be required, the AUTOSTART function (automatic start mode) may be activated, thus allowing the start of the circulator directly by pressing the mains power switch or using a timer.

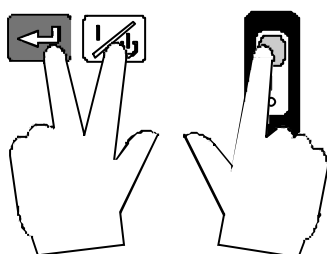
**Automatic / non-automatic start mode**



**Activating/deactivating AUTOSTART**

- 1 Press enter  and the start/stop key  at the same time,
- 2 and turn on the circulator with the mains power switch.

For a short while the MULTI-DISPLAY indicates the effective start mode:

 ⇒ AUTOSTART on.

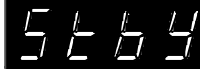
 ⇒ AUTOSTART off.



**Warning:**

For supervised or unsupervised operation with the AUTOSTART function, avoid any hazardous situation to persons or property.

The circulator does no longer conform to N.A.M.U.R. recommendations.





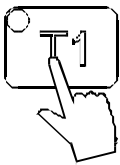

Take care you fully observe the safety and warning functions of the circulator.

If the setpoint is given via the serial interface, no AUTOSTART is possible.

### 6.3. Setting the temperatures



#### Setting the working temperature "T1":

- ① Press the setpoint key .  
The indicator light **blinks** and the value previously set appears on the MULTI-DISPLAY (LED).
- ② Use the cursor keys   to move left or right on the display until the numeral you wish to change is blinking.
- ③ Use the increase/decrease arrows   to change the selected numeral (-, 0, 1, 2, 3, ... 9).
- ④ Press enter  to store the selected value (example: -15.0 °C).



The working temperature is maintained constant after a short heat-up time (e. g. -15.0 °C).

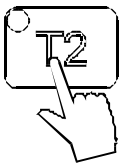





#### Setting the working temperature "T2":

- ① Press the setpoint key .
- ② Same procedure
- ③ as with "T1"
- ④ (example: 25.0 °C).



#### Selecting the working temperature:

- Press the setpoint key  and then enter .
- Press the setpoint key  and then enter .

## 6.4. Warning functions

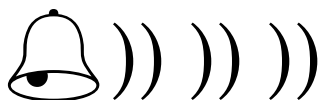

More protection for your samples in the bath!



An audible signal sounds in intervals when the actual temperature value exceeds one of the set limits (patented function).



### Setting the high temperature limit:



- ① Press the key .

The indicator light **blinks** and the value previously set appears on the MULTI-DISPLAY (LED).

- ② Use the cursor keys   to move left or right on the MULTI-DISPLAY (LED) until the numeral you wish to change is blinking.

- ③ Use the edit keys   to increase or decrease the numeral value (-, 0, 1, 2, 3, ... 9).

- ④ Press enter  to store the value (example: -13.0 °C).



### Setting the low temperature limit:



- ① Press the key .

- ② Follow the instructions

- ③ for .

- ④ (example: -17.0 °C).



#### Note:

The warning functions will only be triggered when the actual bath temperature, after start from the „OFF“ or „rOFF“ mode, lies within the set limits for 3 seconds.

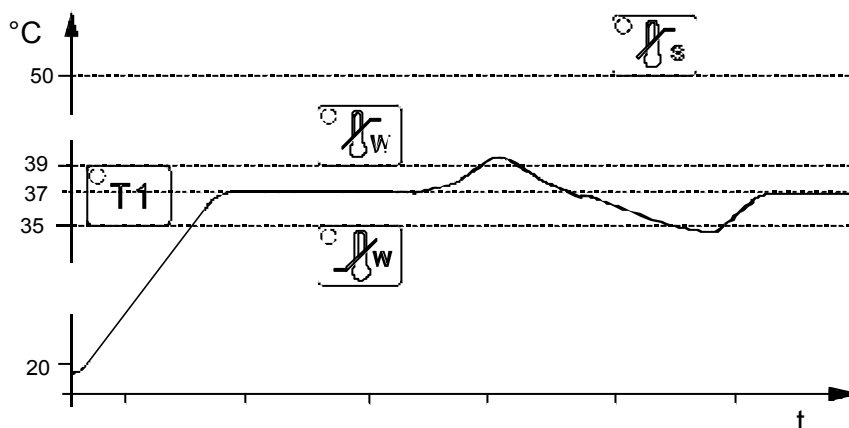

### 6.5. Setting the safety temperature (with shutdown function)

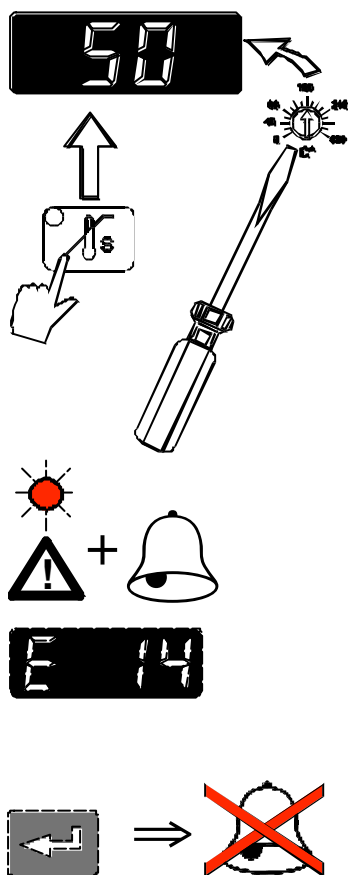

(excess temperature protection)

- Press the key to indicate the safety temperature value on the MULTI-DISPLAY (LED) and using a screwdriver simultaneously turn the setting screw to the desired value (example: 50 °C).

**Setting range:** 0 °C to 320 °C  
in 2 °C steps

This safety installation is independent of the control circuit. When the temperature of the bath liquid has reached the safety temperature, a complete shutdown of the heater and pump is effected.

The alarm is indicated by optical and audible signals (continuous tone) and on the MULTI-DISPLAY (LED) appears the error message "Error 14".

Cancel the alarm state (see page 26).

**Recommendation:**

Set the safety temperature at 5 to 10 °C above the working temperature setpoint.



**The excess temperature protection should be set at least 20 °C below the fire point of the bath liquid used.**

**In the event of wrong setting there is a fire hazard!**

**We disclaim all liability for damage caused by wrong settings!**

## 6.6. Internal / external control



The circulator is suitable for temperature control in the internal bath as well as in the external system (loop circuit).

- Press the key  in operating state „OFF“ to select the control type.

### Internal control:

- The indicator light in the key  is not illuminated.

### External control:



#### Setup:





ext. Pt100

- Connect a Pt100 sensor to the socket on the rear of the circulator, if necessary perform a calibration using the Atc2 function (see page 21) and then securely fix the sensor in the external system.

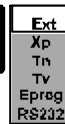

- Press the key  to switch to external control (example: T1). The indicator light in the key  illuminates.



- Press the start/stop key . The MULTI-DISPLAY (LED) automatically indicates the temperature value registered by the Pt100 sensor (example: -15.0 °C).

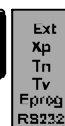

- Switch the display to indicate the internal/external value: Press the key  to indicate the temperature value registered by the internal measurement sensor (example: -15.8 °C).



**Place the external sensor into the bath medium and securely fix the sensor.**

### 6.7. PID control parameters

When performing an identification for the controlled system (temperature application system) (see page 21), the control parameters  $X_p$ ,  $T_n$ , and  $T_v$  will be automatically determined and stored.

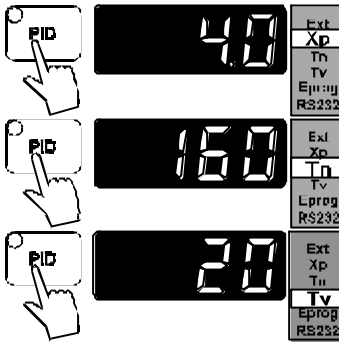

#### Indication of control parameters:

Press the key to indicate the parameters in succession:

- 1)  $X_p$  parameter (example 4.0 °C).
- 2)  $T_n$  parameter (example 160 s).
- 3)  $T_v$  parameter (example 20 s).

Each parameter may be manually set via the keypad to allow optimum control performance.

#### Setting the control parameters::

- ① Press the key and select the parameter.
- ② Use the cursor keys to move left or right on the display until the numeral you wish to change is blinking.
- ③ Use the increase/decrease arrows to change the selected numeral (-, 1, 2, 3, ... 9).
- ④ Press enter to store the selected value (example:  $X_p$  parameter set to 4.2 °C)



#### Optimization instructions for the PID control parameters:

The heat-up curve reveals inappropriate control settings (example: working temperature  $T_1$ ).

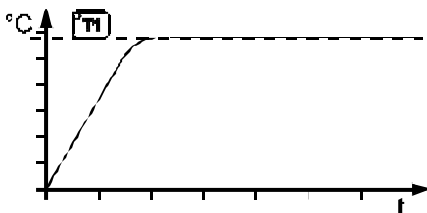

optimum setting

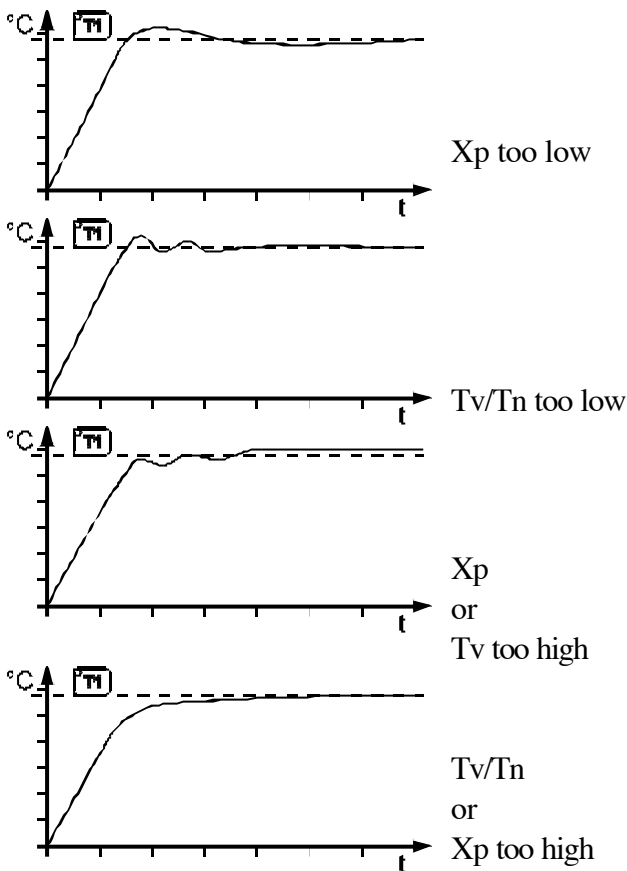

Inappropriate settings may produce the following heat-up curves:



## 7. Menu functions





Set the parameters for the circulator via the configuration level.

### Selecting/exiting the configuration level.

- Simultaneously press the cursor key  and enter .
- The first menu item is "Atc0".





### Selecting and setting menu items.

- Select the menu items in succession by pressing the cursor keys  .
- Set the parameter for each menu item using the edit keys   and store with enter .

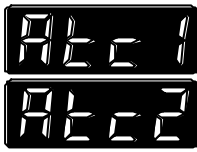
## 7.1. ATC - Absolute Temperature Calibration



- With the edit keys   select "Atc1" (internal sensor) or "Atc2" (external sensor) and then press enter .

### Atc1:

Serves to compensate a temperature difference that might occur between circulator ( $T_T$ ) and a defined measuring point ( $T_M$ ) in the bath tank because of physical properties.

Circulator ( $T_T$ )



### Note:







Setting of Atc1 is recommended for temperature applications in the circulator bath.

Measuring point ( $T_M$ )



- The difference temperature is determined ( $\Delta T = T_M - T_T$ ) and stored as correcting factor (example  $\Delta T = -0.2 \text{ }^\circ\text{C}$ ) for Atc1.

### Example: Setting the correcting factor.

- Use the cursor keys   and the edit keys   to set the correcting factor (example  $-0.20 \text{ }^\circ\text{C}$ ) and then press enter .
- Simultaneously press the cursor key  and enter  to exit the configuration level.
- 

Measuring point ( $T_M$ )



The temperature on the measuring point rises to a temperature of  $-15.0 \text{ }^\circ\text{C}$  and is indicated on the MULTI-DISPLAY (LED).



### Note:

The correcting factor always affects the actual working temperature, even if this is set via the interface.



### Recommendation:

In case a calibrated temperature measuring instrument is used, the ATC function allows the circulator to be used as testing instrument according to ISO 9000.



Circulator ( $T_T$ )

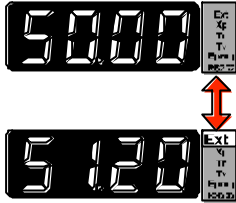

External sensor ( $T_{Pt100}$ )

**Atc2:**

Serves to calibrate a connected Pt100 sensor.

- Immerse the Pt100 sensor in the external bath and wait until a constant bath temperature (example: 50 °C) is maintained.
- Press the **DISPLAY** key to indicate the temperature value registered by the external Pt100 sensor ( $T_{Pt100}$ ) instead of the temperature from the circulator ( $T_T$ ).
- Determine the difference temperature and store the value as correcting factor for Atc2.  
(example:  $\Delta T = T_T - T_{Pt100} = -1.2 \text{ } ^\circ\text{C}$ )



**The ATC function stays activated until resetting to 00.00 °C.**

**7.2. Id - Identification**

When performing an identification for the controlled system (temperature application system), the control parameters  $X_p$ ,  $T_n$ , and  $T_v$  (see page 18) will be automatically determined and stored.

Possible parameters:

0 - No identification

The control parameters ascertained during the last identification are used for control purposes.

1 - Single identification

The circulator performs a single identification of the controlled system after start.

After the identification process the parameter is reset to "0". When the circulator is powered down by pressing the power switch off and on again, the parameter is automatically set to „1“.

2 - Continual identification

The circulator performs an identification of the controlled system whenever a new setpoint is to be reached.

**NOTE:** Use this setting only when the temperature application system changes permanently.



**Note:**

Requirement for an identification of the controlled system:

- The circulator must heat to a setpoint temperature at least 10 °C above the previous setpoint.

When the adjusted control parameters  $X_p$ ,  $T_n$  and  $T_v$  are too high, this requirement may not be given with respect to on how much the setpoint temperature has to change. In this case, prior to carrying out an identification in the „OFF“ state, set the control parameters to lower values.

Recommended setting for internal control:

$$X_p = 1.0 \text{ } ^\circ\text{C}$$

$$T_n = 80 \text{ s}$$

$$T_v = 8 \text{ s}$$

**7.3. h - Heater capacity**

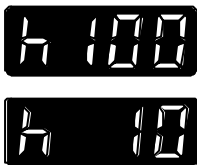

The heater capacity is adjustable.

The heater capacity data indicated in the technical specifications conforms to a setting of 100 %.

Possible parameters:

from 10 % to 100 % in 10 % steps.

**7.4. r - Remote**



Remote control for the circulator can be performed via the serial RS232/RS485 interface or the analog “REG+E-PROG“ connector.

Possible parameters:

0 - Keypad control



RS232

1 - Remote control via the serial RS232 interface by a PC or superordinated data system.



REG+E-PROG

2 - Control by a programmer via the analog“REG+E-PROG“ connector (see menu item Pr - programmer type).



RS485

3 - Remote control via the serial RS485 interface by a PC or superordinated data system.

### 7.5. br - Baud rate



Baudrate of the serial interface

Possible parameters:

- 1200 bauds
- 2400 bauds
- 4800 bauds
- 9600 bauds

### 7.6. P - Parity



Parity bits of the serial interface

Possible parameters:

- 0 = no parity
- 1 = odd parity
- 2 = even parity

### 7.7. H - Handshake



Handshake of the serial interface

Possible parameters:

- 0 = XOn/XOff, software handshake
- 1 = RTS/CTS, hardware handshake

### 7.8. Sb - Stand-By



External stand-by for emergency switch-off

Possible parameters:

- 0 = stand-by input is ignored
- 1 = stand-by input is active  
(connector see page 30)

### 7.9. Pr - Programmer type





For adapting the programmer input to the connected programmer.

Possible parameters:

- 0 = voltage input      0 to 10 V
- 1 = current input      0 to 20 mA
- 2 = current input      4 to 20 mA

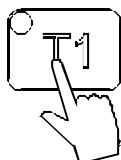
The voltage and current input ranges are fixed and correspond to a temperature range from -100 °C to +400 °C.



Press the setpoint key  and the setpoint value (in °C) appears on the MULTI-DISPLAY (LED).

### 7.10. Ad - Address



For determination of a circulator address for operation via the serial RS485 interface.

(example: Ad32)

Possible parameters: 0 to 99

In case a superordinated data system controls several circulators at one time, commands are directed to the corresponding instrument using the respective circulator address.

The address must stand in front of each command.

### 7.11. Signal level RS232/RS485



The serial interfaces RS232 and RS485 use different output levels.

When the circulator is used in keypad control mode and values are to be called off via the serial interface at the same time, use this menu item for setting the desired signal level.

Possible parameters: c232  
c485

If under the menu item „Remote“ (see page 22) one of the serial interfaces is selected, the signal level is automatically set.

## 8. Troubleshooting guide / Error messages

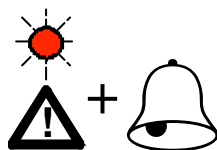

Whenever the microprocessor electronics registers a failure, a complete shutdown of the heater and circulation pump is performed. The alarm light "▲" illuminates and a continuous signal tone sounds.



- The circulator is operated without bath liquid, or the liquid level is insufficient. Replenish the bath tank with the bath liquid.
- Tube breakage has occurred (insufficient filling level due to excessive bath liquid pumped out). Replace the tubing and replenish the bath tank with the bath liquid.
- The float is defect (e. g., because damaged in transit). Repair by authorized JULABO service personnel.



- During the self-test after switch-on a short-circuit is registered between pin 2 and pin 4 of the control cable or the control cable is interrupted during operation.  
Reconnect the cable or eliminate the short-circuit.



- Cable of the working temperature sensor interrupted or short-circuited.



- Defect of the working or safety temperature sensor.  
Working temperature and safety sensors report a temperature difference of more than 25 °C.



- Other errors.



- Error in A/D converter.



- Safety sensor defect.
- The safety temperature value lies below the working temperature setpoint.  
Set the safety temperature to a higher value.



- External control selected, but external Pt100 sensor not connected.









- Heating circuit interrupted.



- Heating circuit short-circuited.



- Defective alarm relay.

**Warnings without a complete shutdown of the unit: E 21 to E 24**

- Cooling of the condenser is affected. Clean air-cooled condenser. Check the flow rate and cooling water temperature on water-cooled condenser.
- Compressor stage 1 does not work.
- Compressor stage 2 does not work.

Cooling compressor overload protection

The motor of the cooling compressor is equipped with an overload protector, which will be activated by excessive temperature in the capsule or by excessive current consumption.





Causes for motor disconnection:

- poor air circulation
- small distance to walls
- dirt accumulated on condenser
- high ambient temperature
- switch-off and on for short intervals

- Excess temperature on compressor stage 1.
- Excess temperature on compressor stage 2.

This message appears every 10 seconds as long as the compressor is not switched on although requested by the circulator.

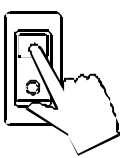
**After a short cooling interval, the motor will be automatically reconnected and the message "E xx" no longer appears.**



  

  

  

- Control cable of the refrigerated circulator short-circuited during self-test.

Press enter  to quit the audible signal.

After eliminating the malfunction, press the mains power switch off and on again to cancel the alarm state.

If the unit cannot be returned to operation, contact an authorized JULABO service station.

- Special message "Configuration **Error**"  
The configuration of the circulator does not conform to its present use.
- Press enter  to automatically perform a single modification of the configuration.  
Then contact an authorized JULABO service station.



- Special message "E OFF" see page 30.

**Disturbances that are not indicated.**

Pump motor overload protection

- The pump motor is protected against overloading. After a short cooling interval, the motor will automatically start running.

**Fuses**

- The mains fuses on the rear of the unit may easily be exchanged as shown on the left.

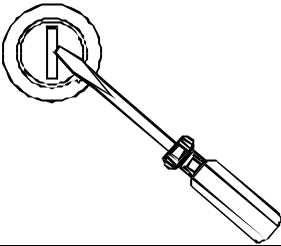

Circulator: Fine fuses T12.5A or M 2.5 A, dia. 5 x 20 mm

Cooling machine: Fine fuses T10A, dia. 5 x 20 mm



**Only use fine fuses with a nominal value as specified.**

## 9. Safety recommendations

Follow the safety recommendations to prevent damage to persons or property. Further, the valid safety instructions for working places must be followed.



- Connect the unit only to a grounded mains power socket!
- Observe the fire point of the bath medium used.  
The excess temperature protection should be set at least 20 °C below the fire point.
- Pay attention to the thermal expansion of bath oil during heating to avoid overflowing of the liquid.
- Prevent water from penetrating into the hot bath oil.
- Some parts of the bath cover and the pump connections may become extremely warm during continuous operation. Therefore, exercise particular caution when touching these parts.
- Exercise caution when emptying hot bath liquids!
- Observe the limited working temperature range when using plastic bath tanks.
- Employ suitable connecting tubing.
- Make sure that the tubes are securely attached.
- Avoid sharp bends in the tubing, and maintain a sufficient distance from surrounding walls.
- Regularly check the tubing for material defects (e.g. for cracks).
- Before cleaning the unit, disconnect the power plug from the mains socket.

## Safety recommendations



### Recommendation:

When you have finished the application, it is recommended to keep on circulating the liquid in the bath or the external system for some time. Simultaneously set the working temperature to +20 °C to allow the temperature in the system to decrease slowly. Thus fractional over-heating of the bath liquid is prevented.

## 10. Electrical connections

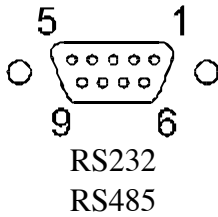

### Serial RS232/RS485 interface (20)

This port can be used to connect a computer with an RS232 or RS485 cable for remote control of the circulator.

#### Pin assignments: RS232

Pin 2	RxD	Receive Data
Pin 3	TxD	Transmit Data
Pin 5	0 VD	Signal GND
Pin 6	DTR	Data terminal ready
Pin 7	RTS	Request to send
Pin 8	CTS	Clear to send

#### Pin assignments: RS485

Pin 3	A	
Pin 5	0 VD	Signal GND
Pin 8	B	
Pins 1, 2, 4, 6, 7, 9		Reserved - do not use!

#### Interface correspondence:

Circulator		Computer		Circulator		Computer
9-pole		25-pole		9-pole		9-pole
Pin 2 RxD	↔	Pin 2 TxD		Pin 2 RxD	↔	Pin 3 TxD
Pin 3 TxD	↔	Pin 3 RxD		Pin 3 TxD	↔	Pin 2 RxD
Pin 5 GND	↔	Pin 7 GND		Pin 5 GND	↔	Pin 5 GND
Pin 6 DTR	↔	Pin 6 DSR		Pin 6 DTR	↔	Pin 6 DSR
Pin 7 RTS	↔	Pin 5 CTS		Pin 7 RTS	↔	Pin 8 CTS
Pin 8 CTS	↔	Pin 4 RTS		Pin 8 CTS	↔	Pin 7 RTS

RS232 interface cable 9-pin / 9-pin, 2,5 m      Order No.: 8 980 073

### Connector for external Pt100 sensor (25)

Pin assignment:

Pin	Signal
1	Current+
2	Voltage+
3	Voltage-
4	Current-

The shield of the connecting cable is electrically connected to the plug housing and the sensor tube.

**Use shielded cables only.**

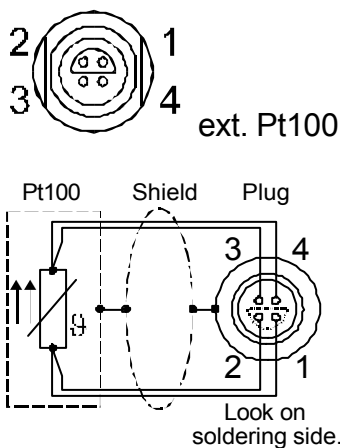

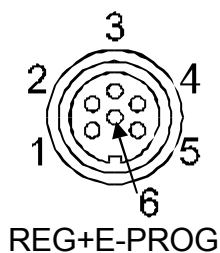

### Programmer input / Temperature recorder output (21)

Pin	Signal
1 Output: temperature external sensor	0 to 10 V <sup>1)</sup>
2 Output: temperature internal sensor ( <sup>1)</sup> 0 V = -100 °C, 10 V = 400 °C)	0 to 10 V <sup>1)</sup>
3 GND for outputs	0 V
4 Input: programmer see „Pr - progammer type“, page 23	
5 Output: setpoint (dependent from the adjustment made under menu item „Pr - progammer type“)	
at Pr 0	0 to 20 mA <sup>2)</sup>
at Pr 1	0 to 20 mA <sup>2)</sup>
( <sup>2)</sup> 0 mA = -100 °C, 20 mA = 400 °C)	
at Pr 2	4 to 20 mA <sup>3)</sup>
( <sup>3)</sup> 4 mA = -100 °C, 20 mA = 400 °C)	
6 GND for programmer	0 V



**Use shielded cables only.**

### ❄ Control output (22)

The ❄ connector may be used for control of JULABO refrigerated circulators or as output for alarm messages.

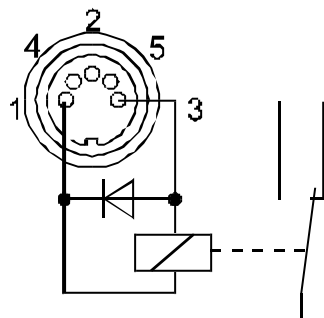

Pin assignment:

Pin	Signal
1	+24 V ( max. current 25 mA)
2	0 V
3	Alarm relay
4	Reserved - do not use!
5	Cooling pulse

Circuit:

Operation = relay powered  
Alarm = relay not powered



**Use shielded cables only.**

### STAND-BY input (23)

(for external emergency switch-off)

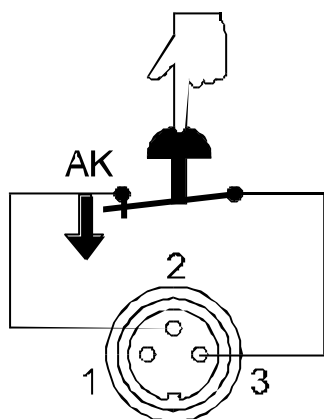

STAND-BY



Pin assignment:	Pin	Signal
	1	not used
	2	5 V / DC
	3	0 V

#### Activate the stand-by input:

- Under menu item Sb, set the parameter to 1 (see page 23).
- Connect an external contact 'AK' (e.g. for emergency switch-off) or an alarm contact of the superordinated system.
- In case the connection between Pin 2 and Pin 3 is interrupted by opening the contact 'AK', a complete shutdown of the circulation pump and heater is effected, and the unit enters the operating state "OFF".
- As long as the contact is open, a flashing „E“ is preceding the message „OFF“ on the MULTI-DISPLAY (LED).  
If the contact is closed, the circulator may be started by pressing the start key

**Use shielded cables only.**

### Alarm output (24)

(for external alarm signal)

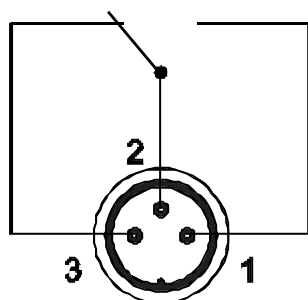

ALARM



This potential-free change-over contact is activated in case of an alarm when pins 2 and 3 are connected.

Switching capacity	max.	30 W / 40 VA
Switching voltage	max.	125 V~/–
Switching current	max.	1 A

**Use shielded cables only.**

### Control connector (26)

To be used as return flow safety device with solenoid valves (see page 11) and/or for supplementary pumps.

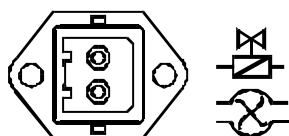

Line voltage:	230 V~ / max. 1.25 A
	115 V~ / max. 2.5 A

## 11. Remote control

### 11.1. Setup for remote control



RS232  
RS485

Interface parameters for the circulator are adjusted via the configuration level.

(Selecting and setting menu items, see page 20)



- Set menu item REMOTE to „1“.



#### Factory settings of the serial interface:

REMOTE            0 = keypad control mode

BAUDRATE        48 = 4800 bauds

PARITY            2 = even parity

HANDSHAKE      1 = Protocol RTS/CTS  
(Hardware handshake)

Data bits        7

Stop bit         1



**Like all parameters which can be entered through the keypad, interface parameters are stored in memory even after the circulator is turned off.**

### 11.2. Communication with a PC or a superordinated data system

Suitable terminal programs for communicating with a PC are:

MS-Windows        - TERMINAL.EXE (included with MS-Windows).

MS-DOS             - Procomm Plus, Datastrom Technologies.

MS-DOS             - Norton Utilities.



If the circulator is put into remote control mode via the configuration level, the display will read "r OFF" = REMOTE STOP.

The circulator is now operated via the computer.

In general, the computer (master) sends commands to the circulator (slave). The circulator sends data (including error messages) only when the computer sends a query.



After a power interruption in case of remote control the order to start and all values which have to be adjusted, must be resent via the interface from the personal computer. AUTOSTART is not possible.

A transfer sequence consists of:

- address (RS485 interface only)
- command
- space (↔, Hex: 20)
- parameter (the character separating decimals in a group is the period)
- end of file (↵; Hex: 0D)

The commands are divided into **in** and **out** commands.

- **in** commands: asking for parameters to be displayed
- **out** commands: setting parameters



**The out commands are valid only in remote control mode.**



When the RS485 interface is used, the three-digit instrument address stands in front of each command.  
(example: address Ad32 = **A032**)

**Examples:**

Command to set the working temperature T1 to 55.5 °C:

**out\_sp\_00 ↔ 55.5↵**  
**A032\_out\_sp\_00 ↔ 55.5↵**

Command to ask for the working temperature T1:

**in\_sp\_00↵**  
**A032\_in\_sp\_00↵**



Response from the circulator:

**55.5↵**  
**A032\_55.5↵**

### 11.3. List of commands



When the RS485 interface is used, the instrument address stands in front of each command (Axxx\_).

**in commands:** Asking for parameters or temperature values to be displayed.

Command	Parameter	Response of circulator
<b>version</b>	none	Number of software version (V X.xx)
<b>status</b>	none	Status message, error message (see below 36).
<b>in_pv_00</b>	none	Actual bath temperature.
<b>in_pv_01</b>	none	Heater wattage being used (%).
<b>in_pv_02</b>	none	Temperature value registered by the external Pt100 sensor.
<b>in_pv_03</b>	none	Temperature value registered by the safety sensor.
<b>in_sp_00</b>	none	Working temperature "T1"
<b>in_sp_01</b>	none	Working temperature "T2"
<b>in_sp_03</b>	none	High temperature warning limit "  ".
<b>in_sp_04</b>	none	Low temperature warning limit "  ".
<b>in_sp_05</b>	none	Setpoint temperature of the external programmer (socket 21 - REG+E-PROG) .
<b>in_hil_00</b>	none	Max. cooling capacity (%).
<b>in_hil_01</b>	none	Max. heater capacity (%).
<b>in_mode_01</b>	none	Selected working temperature: 0 = "T1". 1 = "T2".
<b>in_mode_02</b>	none	Identification type: 0 = no identification 1 = single identification 2 = continual identification

Command	Parameter	Response of circulator
<b>in_mode_03</b>	none	Type of the programmer input: 0 = Voltage 0 V to 10 V 1 = Current 0 mA to 20 mA 2 = Current 4 mA to 20 mA
<b>in_mode_04</b>	none	Internal/external temperature control: 0 = Temperature control in the circulator bath. 1 = Temperature control with external Pt100 sensor.
<b>in_mode_05</b>	none	Circulator in Stop/Start condition: 0 = Stop 1 = Start
<b>in_par_01</b>	none	Time constant of the external bath.
<b>in_par_02</b>	none	Internal slope.
<b>in_par_03</b>	none	Time constant of the internal bath.
<b>in_par_04</b>	none	Bandwidth limit (max. difference between the temperatures in the internal bath and external system).
<b>in_par_05</b>	none	Ratio for max. cooling capacity versus max. heating capacity.
<b>in_par_06</b>	none	Xp control parameter of the internal controller.
<b>in_par_07</b>	none	Tn control parameter of the internal controller.
<b>in_par_08</b>	none	Tv control parameter of the internal controller.
<b>in_par_09</b>	none	Xp control parameter of the cascade controller.
<b>in_par_10</b>	none	Proportional portion of the cascade controller.
<b>in_par_11</b>	none	Tn control parameter of the cascade controller.
<b>in_par_12</b>	none	Tv control parameter of the cascade controller.

<b>out commands:</b> Setting parameters or temperature values.
--

Command	Parameter	Response of circulator
<b>out_mode_01</b>	0	Use working temperature "T1" *
<b>out_mode_01</b>	1	Use working temperature "T2" *
<b>out_mode_02</b>	0	No identification. Temperature control by using the stored parameters.
<b>out_mode_02</b>	1	Single identification of controlled system after the next start.
<b>out_mode_02</b>	2	Continual identification of controlled system whenever a new setpoint is to be reached.
<b>out_mode_04</b>	0	Temperature control of internal bath.
<b>out_mode_04</b>	1	External control with Pt100 sensor.
<b>out_mode_05</b>	0	Stop the circulator = r OFF.
<b>out_mode_05</b>	1	Start the circulator.
<b>out_sp_00</b>	xxx.x	Set working temperature "T1".
<b>out_sp_01</b>	xxx.x	Set working temperature "T2".
<b>out_sp_03</b>	xxx.x	Set high temperature warning limit  .
<b>out_sp_04</b>	xxx.x	Set low temperature warning limit  .
<b>out_hil_01</b>	xxx	Set the desired maximum heater capacity (10 % to 100 %)



(\* see "Note" on page 20)

Command	Parameter	Response of circulator
<b>out_par_04</b>	xxx	Bandwidth limit during external control. Setting the maximum difference between the temperatures in the internal bath and external system.
<b>out_par_05</b>	xxx	Ratio between max. cooling capacity versus max. heater capacity (0...0.99).
<b>out_par_06</b>	xxx	Xp control parameter of the internal controller.
<b>out_par_07</b>	xxx	Tn control parameter of the internal controller.
<b>out_par_08</b>	xxx	Tv control parameter of the internal controller.
<b>out_par_09</b>	xxx	Xp control parameter of the cascade controller.
<b>out_par_10</b>	xxx	Proportional portion of the cascade controller.
<b>out_par_11</b>	xxx	Tn control parameter of the cascade controller.
<b>out_par_12</b>	xxx	Tv control parameter of the cascade controller.

#### 11.4. Status messages / error messages

The circulator sends data (including error messages) only when the computer sends a query.

Status messages	Description
00 MANUAL STOP	Circulator in "OFF" state.
01 MANUAL START	Circulator in keypad control mode.
02 REMOTE STOP	Circulator in "r OFF" state.
03 REMOTE START	Circulator in remote control mode.

Error messages	Description
<b>-01 LOW LEVEL ALARM</b>	Low liquid level alarm
<b>-02 REFRIGERATOR ALARM</b>	Control cable of the refrigerated circulator or MVS solenoid valve controller short-circuited or interrupted.
<b>-03 EXCESS TEMPERATURE WARNING</b>	High temperature warning "  ".
<b>-04 LOW TEMPERATURE WARNING</b>	Low temperature warning "  ".
<b>-05 WORKING SENSOR ALARM</b>	Working temperature sensor short-circuited or interrupted.
<b>-06 SENSOR DIFFERENCE ALARM</b>	Sensor difference alarm. Working temperature and safety sensors report a temperature difference of more than 25 °C.
<b>-07 I<sup>2</sup>C-BUS ERROR</b>	Internal error when reading or writing the I <sup>2</sup> C bus.
<b>-08 INVALID COMMAND</b>	Invalid command.
<b>-09 COMMAND NOT ALLOWED IN CURRENT OPERATING MODE</b>	Invalid command in current operating mode.
<b>-10 VALUE TOO SMALL</b>	Entered value too small.
<b>-11 VALUE TOO LARGE</b>	Entered value too large.
<b>-12 TEMPERATURE MEASUREMENT ALARM</b>	Error in A/D converter.
<b>-13 WARNING : VALUE EXCEEDS TEMPERATURE LIMITS</b>	Value lies outside the adjusted range for the high and low temperature warning limits. But value is stored.
<b>-14 TEMPERATURE/LEVEL ALARM</b>	Safety temperature alarm 
<b>-15 EXTERNAL SENSOR ALARM</b>	External control selected, but external Pt100 sensor not connected.
<b>-16 TRIAC/RELAY CONNECTION OPEN</b>	Heating circuit interrupted.
<b>-17 TRIAC SHORTED</b>	Heating circuit short-circuited.
<b>-18 RELAY SHORTED</b>	Defective alarm relay.

Error messages	Description
<b>-20 WARNING: CLEAN CONDENSOR OR CHECK COOLING WATER CIRCUIT OF REFRIGERATOR</b>	Cooling of the condenser is affected. Clean air-cooled condenser. Check the flow rate and cooling water temperature on water-cooled condenser.
<b>-21 WARNING: COMPRESSOR STAGE 1 DOES NOT WORK</b>	Compressor stage 1 does not work.
<b>-22 WARNING: COMPRESSOR STAGE 2 DOES NOT WORK</b>	Compressor stage 2 does not work.
<b>-23 WARNING: HIGH TEMPERATURE ON COMPRESSOR STAGE 1</b>	Excess temperature on compressor stage 1.
<b>-24 WARNING: HIGH TEMPERATURE ON COMPRESSOR STAGE 2</b>	Excess temperature on compressor stage 1.
<b>-25 REFRIGERATOR WARNING</b>	Error in the cooling machine.
<b>-26 WARNING: STAND-BY PLUG IS MISSING</b>	External stand-by contact is open. Stand-by input - see pages 23 and 30.
<b>-30 CONFIGURATION ERROR: CONFIRM BY PRESSING &lt;ENTER&gt; ON CIRCULATOR</b>	The configuration of the circulator does not conform to its present use. Press enter  to automatically perform a single modification of the configuration. (Then contact an authorized service station).

## 12. Maintaining the cooling performance

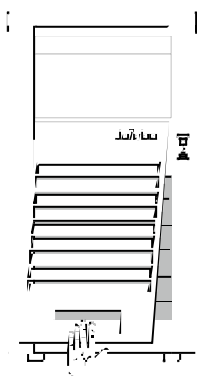

To maintain the full cooling performance, clean the condenser from time to time.

- Switch off the unit, disconnect mains power cable.
- Hold the venting grid, pull out and remove.
- Clean the ribbed condenser with a vacuum cleaner.
- Replace the venting grid.
- Switch on the unit.

## 13. Cleaning the unit, Maintenance



**Before cleaning the unit, disconnect the power plug from the mains socket!**

**Prevent humidity from entering into the circulator.**

For cleaning the bath tank and the immersed parts of the circulator, use low surface tension water (e.g., soap suds).

Clean the outside of the unit using a wet cloth and low surface tension water

The circulator is designed for continuous operation under normal conditions. Periodic maintenance is not required.

The tank should be filled only with a bath liquid recommended by JULABO. To avoid contamination, it is essential to change the bath liquid from time to time.

### **Repairs**

**Before asking for a service technician or returning a JULABO circulator for repair, please contact an authorized JULABO service station.**

When returning a unit, take care of careful and adequate packing. JULABO is not responsible for damages that might occur from insufficient packing.



JULABO reserves the right to carry out technical modifications with repairs for providing improved performance of a unit.

## 14. Technical specifications

	HD	SD
Temperature selection via keypad		digital indication on MULTI-DISPLAY (LED)
remote control via personal computer		indication on monitor
Temperature indication		MULTI-DISPLAY (LED)
Resolution	°C	0.01 from -9.99 °C to +99.99 °C
	°C	0.1 from ≤ -10.0 °C to ≥ +100.0 °C
<b>Absolute Temperature Calibration:</b>		
ATC1	°C	±3
ATC2	°C	±9
Temperature control		PID
Working temperature sensor		Pt100
Safety temperature sensor		Pt100
Heater wattage	W	2000 (at 230 V)
	W	1000 (at 115V)
2000 (at 230 V)		2000 (at 230 V)
1000 (at 115V)		1000 (at 115V)
<b>Pressure pump:</b>		
pressure, max. psi at 0 liters	5	8.2
discharge, max.	Lpm at 0 psi	20
		24
<b>Suction pump:</b>		
suction, max.	psi at 0 liters	3.2
discharge, max.	Lpm at 0 psi	14
		16
<b>Electrical connections:</b>		
Computer interface RS232/RS485		
Programmer input -100 °C to 400 °C =		0 - 10 V or 0 - 20 mA or 4 - 20 mA
Temperature recorder output		0 - 10 V (0 V = -100 °C, 10 V = 400 °C)
		0 - 20 mA (0 mA = -100 °C, 20 mA = 400 °C)
		4 - 20 mA (4 mA = -100 °C, 20 mA = 400 °C)
Stand-by input		
Alarm output 24 to 0 V DC / max. 25 mA		
External measurement and control sensor - Pt100		
Control connectors for solenoid valves or supplementary pump - 230 V or 115 V / max. 1.25 A		
Mains power connection	V/ Hz	230 / 50
(±10 %)	V/ Hz	or 115 / 60
Total power consumption (at 230 V)	Watts	2400
(at 115 V)	Watts	1400

All measurements have been carried out at:

rated voltage and frequency                      ambient temperature: 20 °C

Technical changes without prior notification reserved.

## Technical specifications

---

		FP40-HD/-SD	FP45-HD/-SD
Working temperature range	°C	-38 ... 200	-42 ... 200
Temperatur stability	°C	±0.01	±0.01
Cooling capacity	°C	<u>+20 0 -20 -30</u>	<u>+20 0 -20 -40</u>
(bath liquid: ethanol)	Watts	680 500 320 180	850 700 420 80
Refrigerant		R404a	R404a
Ambient temperature	°C	5... 40	5... 40
Mains power connection (±10 %)	V/ Hz	230 / 60 or 230 / 50	230 / 60
Total power consumption	Watts	3000/3050	3100/3150
Bath opening (WxD)/ bath depth	cm	23x14/20	23x26/20
	in.	9x5½ /8	9x10/8
Filling volume liters	9 ... 16	18 ... 26	
Overall dimensions (WxDxH)	cm	37x46x70/75	38x58x68/73
Weight	Lbs	99/106	117

		FP50-HD/-SD
Working temperature range	°C	-50 ... 200
Temperatur stability	°C	±0.01
Cooling capacity	°C	<u>+20 0 -20 -40 -50</u>
(bath liquid: ethanol)	Watts	900 800 500 160 50
Refrigerant		R507
Ambient temperature	°C	5... 40
Mains power connection (±10 %)	V/ Hz	230 / 60 or 230 / 50
Total power consumption	Watts	3100/3150
Bath opening (WxD)/ bath depth	cm	18x12/15
	in.	7x5/6
Filling volume	liters	5,5 ... 8
Overall dimensions (WxDxH)	cm	42x50x71/76
Weight	Lbs	128

		FS18-HD	F25-HD	F26-HD
Working temperature range	°C	-30 ... 150	-25 ... 200	-25 ... 200
Temperatur stability	°C	±0.01	±0.01	±0.01
Cooling capacity (bath liquid: ethanol)	°C Watts	<u>+20 0 -20</u> 460 340 150	<u>+20 0 -20</u> 260 200 60	<u>+20 0 -20</u> 260 200 60
Refrigerant		R134a	R134a	R134a
Ambient temperature	°C	5... 40	5... 40	5... 40
Mains power connection (±10 %)	V/ Hz V/ Hz	230 / 50 or 115 / 60	230 / 50 or 115 / 60	230 / 50 or 115 / 60
Total power consumption	Watts	2770 or 1770	2600 or 1600	2600 or 1600
Bath opening (WxD)/ bath depth	cm in.		12x14/12 5x5 ½ /6	12x14/12 5x5 ½ /6
Filling volume liters	1.7 ... 3	3 ... 4,5	3 ... 4,5	
Overall dimensions (WxDxH)	cm	31x43x65	23x42x63	42x42x44
Weight	Lbs	86	73	71
		F32-HD	F33-HD/SD	F34-HD
Working temperature range	°C	-32 ... 200	-30 ... 200	-30 ... 150
Temperatur stability	°C	±0.01	±0.01	±0.01
Cooling capacity (bath liquid: ethanol)	°C Watts	<u>+20 0 -20 -30</u> 380 340 150 50	<u>+20 0 -20</u> 500 320 120	<u>+20 0 -20</u> 450 320 140
Refrigerant		R134a	R134a	R134a
Ambient temperature	°C	5... 40	5... 40	5... 40
Mains power connection (±10 %)	V/ Hz V/ Hz V/ Hz	230 / 50 or 115 / 60	230 / 50 or 115 / 60 230 / 60	230 / 50 or 115 / 60
Total power consumption	Watts	2770 or 1770	2750 or 1750 2800 (SD)	2680 or 1680
Bath opening (WxD)/ bath depth	cm in.	18x12/12 7x5 /6	23x14/ 20 9x5 ½ /8	24x30/ 15 9 ½ x12 /8
Filling volume liters	5.5 ... 8	12 ... 16	14 ... 20	
Overall dimensions (WxDxH)	cm	31x43x65	37x46x70/75	38x58x63
Weight	Lbs	84	90 / 99	108

<u>Safety Installations (DIN 12876)</u>	
Excess temperature protection	adjustable from 0 to 320 °C
Low liquid level protection	float switch
Safety class	III
<u>Supplementary safety installations:</u>	
High temperature warning function	optical + audible (in intervals)
Low temperature warning function	optical + audible (in intervals)
Supervision of the working sensor	plausibility control
Reciprocal sensor monitoring between working and safety sensors	difference >25 °C
Alarm indication	optical + audible (continuous tone)

<u>Standards:</u>	
EMC regulations	EN 61326
Guideline for first voltage range	EN 61010-1, EN 61010-2-010
Pressure equipment directive	EN 378

<u>Only for water-cooled models:</u>		
Cooling water pressure (IN / OUT )	max.	6 bar
Difference pressure (IN - OUT )		3.5 to 6 bar
Cooling water temperature		<20 °C
<u>Quality of cooling water:</u>		
pH at 25 °C		7 to 8.5
Suspended matter		<30 mg/l
Size of suspended matter	max.	0.1 mm
Growth of algae		not permissible

## 15. Warranty conditions

JULABO USA, Inc. warrants its products against defects in material or in workmanship, when used under appropriate conditions and in accordance with appropriate operating instructions for a period of no less than

### **TWO (2) YEARS**

or a maximum of ten thousand hours (10,000), whichever comes first, from the date of delivery of the products. To avoid forfeiture of the warranty and to allow JULABO to be of continuing service to the scientific community, the record of the purchase is required to be returned to JULABO or one of its authorized representatives within 30 days of receipt of equipment.

JULABO's sole obligation shall be to repair or to replace at JULABO's option, F.O.B. its plant or locally, without charge, any part(s) that prove defective within the warranty period, providing the customer notifies JULABO promptly and in writing of any such defect. Compensation for labor other than Julabo's employees will not be JULABO's obligation. Part(s) replacement does not constitute an extension of the original warranty period.

JULABO will not assume responsibility for unauthorized product modifications, or for repairs, replacements, or modifications negligently or otherwise improperly made or performed by persons other than JULABO employees or authorized representatives.

JULABO MAKES NO WARRANTY OR MERCHANTABILITY, FITNESS FOR A PARTICULAR PURPOSE, OR ANY OTHER WARRANTY, EXPRESS OR IMPLIED, AS TO THE DESIGN, SALE, INSTALLATION, OR USE OF ITS PRODUCTS, AND SHALL NOT BE LIABLE FOR CONSEQUENTIAL DAMAGES RESULTING FROM THE USE OF ITS PRODUCTS.

While JULABO's personnel or that of its authorized representatives are available to advise customers concerning general applications of all manufactured products, oral representations are not warranties with respect to particular applications, and should not be relied upon if inconsistent with product specifications or the terms stated herein.

All glassware, such as reference thermometers, etc, are expressly excluded from this warranty declaration.

In any event, the terms and conditions contained in JULABO's formal sales contracts shall be controlling and any change must be in writing and signed by an authorized executive of JULABO USA, Inc.